

PULP & PAPER

Advanced Gearing Solutions
for Pulp & Paper Mills



HORSBURGH & SCOTT
DELIVERING THE DIFFERENCE

*Delivering the Difference with
the company most qualified to
handle all your gearing needs.*

PULP & PAPER APPLICATIONS

- Long Wood Deck
- Infeed Deck
- De-barking Drum
- Chipper Feed
- Bark Hog
- Bark Transfer
- Truck Dump Wood Chip Hopper
- Chip Pile Stacker Reclaimer
- Ash Conveyor
- Waste Wood Infeed
- Turbine
- Salt Cake Agitator
- Lime Kiln Drum Ring Gear and Gearbox
- Mixers
- Hydro Pulpers
- Screw Conveyors
- All Drive Rolls
- Press Rolls
- Wire Turning Rolls
- Dryer Can Gears
- Line Shaft Turbine
- Unwinder / Rewinder
- Vacuum Pumps
- Flat Top Floor Chain Drive



HIGHEST QUALITY
CUSTOM GEARING

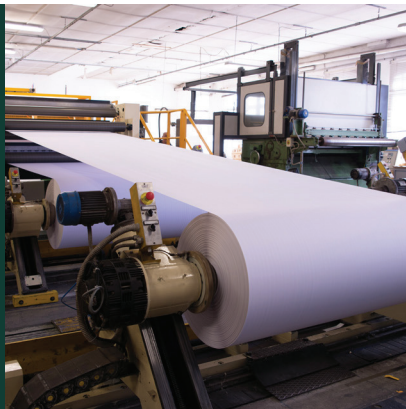

24/7 EXPERT
ON-SITE
DIAGNOSTICS,
MAINTENANCE
AND REPAIR



REVERSE ENGINEERING
AND PERFORMANCE
UPGRADES FOR
GEARBOX REBUILD
AND REPAIR



EXPERT GEAR
AND GEARBOX
EVALUATION



Advanced Gearing Solutions For Pulp & Paper

Horsburgh & Scott is known for providing the most innovative and highest quality custom gearing that will streamline pulp & paper operations and stand up to demanding plant usage.

SERVICES

- Gear inspections
- Gearbox no-load spin testing
- Detailed bore scope inspections
- Non-destructive testing
- FARO Arm on-site measurement for reverse engineering competitive gear drives and gearing
- Laser alignment of shafts
- New bed/sole plates
- Field service

DROP-IN
REPLACEMENT
DRIVES AND
ON-SITE REPAIRS

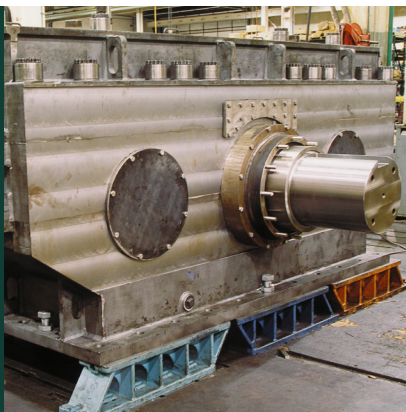

GEAR DRIVE SYSTEMS
AND ALL OTHER GEARING
FOR PULP & PAPER
APPLICATIONS

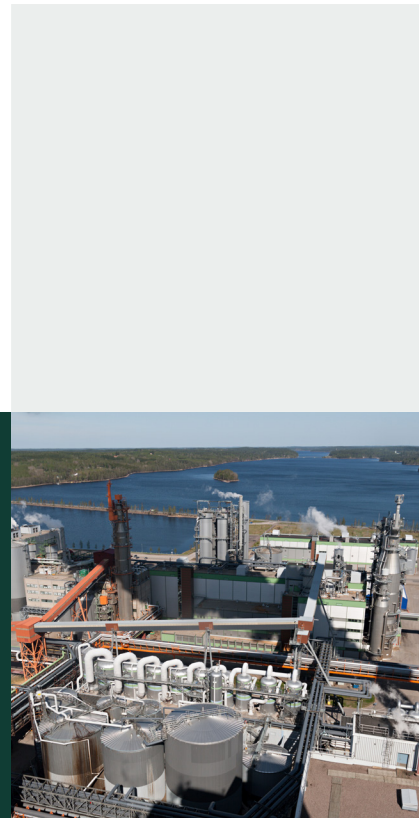

THE EXPERT IN
REBUILDS AND
UPGRADES



Our Unique Expertise to Keep Your Pulp & Paper Operations Running

Horsburgh & Scott understands that in the pulp & paper industry downtime is very costly. We have extensive experience in engineering, manufacturing, and rebuilding large gear systems.

ADVANTAGES

MAXIMIZE PROFITABILITY with gear and gearbox re-engineering and performance upgrades

INCREASED YIELD and decreased operating costs

PREVENTATIVE MAINTENANCE programs increase uptime

FASTEST TURNAROUND TIME in the gearing industry

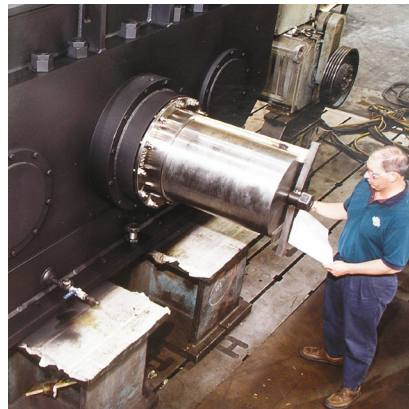

**MORE ENGINEERS
ON STAFF THAN
ANY OTHER
COMPANY IN
GEARING**



**EQUIPMENT TO
HANDLE EVEN THE
LARGEST DRIVES
AND GEARBOXES**

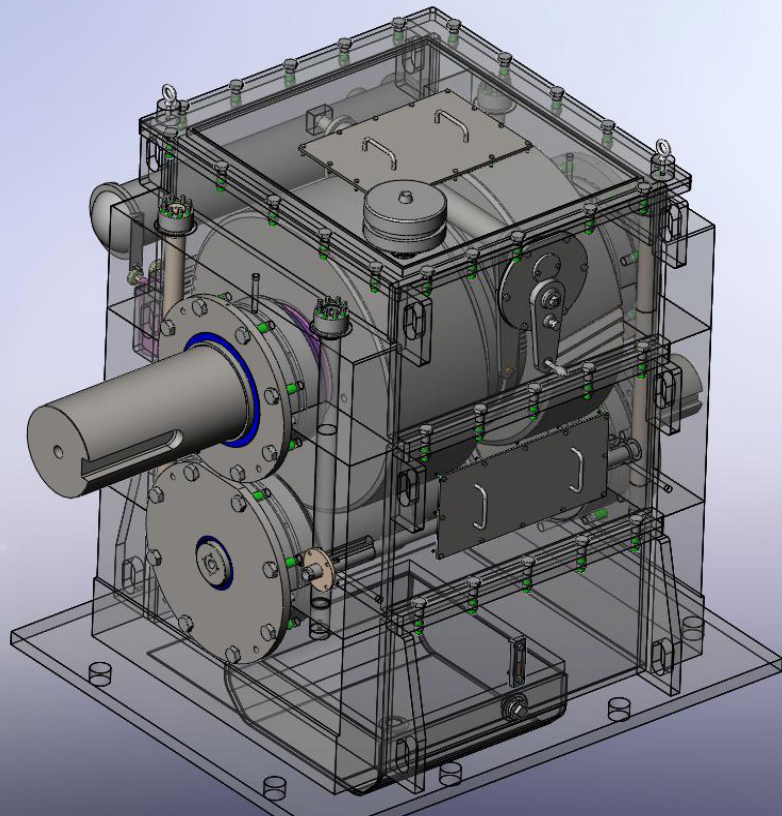

Delivering the Difference for
Higher Productivity



HORSBURGH & SCOTT
DELIVERING THE DIFFERENCE

Over 135 Years of Industry Leadership

Horsburgh & Scott has over 135 years of engineering expertise in high torque, large gear drive systems. We use the world's most advanced gear cutting equipment and can duplicate virtually any gear geometry.

TURNKEY SOLUTIONS

- Gears up to 40 ft (12m) in diameter
- Grinding to AGMA Class 14
- Heat treating and carburizing up to 50,000 lbs (22,000 kg)
- Induction hardening to 5m in diameter or 30,000 lbs (13,000 kg)
- Quality measurements within 2 microns
- Inspection and testing

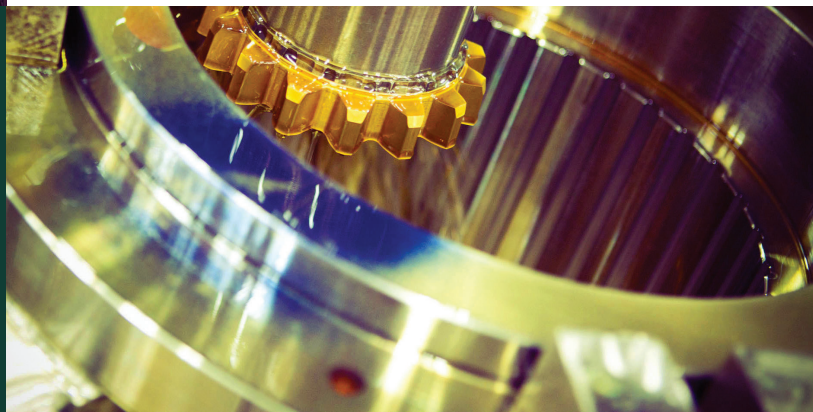

 216/431/3900

 inquiry@horsburgh-scott.com

 horsburgh-scott.com

Cleveland, Ohio | Roscoe, Illinois | Slidell, Louisiana | Sudbury, Ontario

5114 Hamilton Avenue
Cleveland, Ohio 44114
USA